

METALMASTER

HYDRAULIC NC PANBRAKE OPERATION MANUAL



Models.

PB-422L, PB-820L

Order Code S576, Order Code S583

Edition No : PB-422,820 - 1

Date of Issue : 07/2019

www.machineryhouse.com.au



OPERATION MANUAL

MACHINE DETAILS

MACHINE	<input type="text" value="HYDRAULIC NC PANBRAKE"/>
MODEL NO.	<input type="text"/>
SERIAL NO.	<input type="text"/>
DATE OF MANF.	<input type="text"/>

Distributed by



www.machineryhouse.com.au

www.machineryhouse.co.nz

Note:

This manual is only for your reference. Owing to the continuous improvement of these Metalmaster machine, changes may be made at any time without obligation or notice. Please ensure the local voltage is the same as listed on the specification plate before operating any electric machine.



NOTE:

In order to see the type and model of the machine, please see the specification plate. Usually found on the back of the machine. See example (Fig.1)

METALMASTER	
PRODUCT SPECIFICATION	
MODEL:	<input type="text"/>
CAPACITY:	<input type="text"/>
SER. NO:	<input type="text"/>
MFG DATE:	<input type="text"/>
WEIGHT:	<input type="text"/>
VOLTS:	<input type="text"/>
MOTOR Kw:	<input type="text"/>
www.machineryhouse.com.au Made in China	

Fig.1



OPERATION MANUAL

CONTENTS:

1. GENERAL MACHINE INFORMATION	
1.1 Specifications.....	4
1.2 Accessories.....t.....	4
1.3 Identification.....	5
2. IMPORTANT INFORMATION	
2.1 General Safety Requirements.....	6
2.2 Safety Specific To Panbrakes.....	9
2.3 Lifting Instructions.....	10
3. SETUP	
3.1 Site Preparation.....	11
3.2 Clean Up.....	11
3.3 Machine Leveling.....	12
3.4 Electrical Installation.....	13
3.5 Full Load Current.....	13
3.6 Attaching the Accessories.....	14
3.7 Filling The Oil Tank.....	14
4. OPERATION	
4.1 Setting The Clap Gap.....	15
4.2 Operating Controls.....	16
4.3 Controller Operation.....	17
4.4 Start Up.....	19
4.5 Bending.....	19
5. MAINTENANCE	
5.1 Type and frequency of Inspections.....	19
5.2 Changing The Hydraulic Oil.....	20
5.3 Changing The Hydraulic Oil Filter.....	20
5.4 Troubleshooting.....	21
Spare Parts.....	22
Risk Assessment.....	25



OPERATION MANUAL

1.1 SPECIFICATIONS

Order Code	S576	S583
MODEL	PB-422L	PB-820L
Controller Type	Digital Single Program	Digital Single Program
Bending Length (mm)	1250	2500
Mild Steel Capacity (mm)	2	2
Stainless Steel Capacity (mm)	1	1
Material Clamping Type	Hydraulic Clamp	Hydraulic Clamp
Material Bending Type	Hydraulic Bend	Hydraulic Bend
Bending Angle Indicator (deg)	0-125°	0-125°
Backgauge Travel (mm)	1000	1000
Motor (kW/hp)	2.2/3	2.2/3
Voltage (V)	240	240
Amperage (A)	15	15
Dimensions (L x W x H) (cm)	170 x 180 x 130	290 x 180 x 130
Shipping Dimensions (L x W x H) (cm)	190 x 80 x 145	300 x 80 x 145
Nett Weight (kg)	1100	1600

1.2 ACCESSORIES

- Roving Foot Pedal With Control Panel
- Adjustable Rear Manual Backgauge
- Hydraulic Oil
- Manual

NOTE: The above specifications were current at the time this manual was published, but because of our policy of continuous improvement, Metalmaster reserves the right to change specifications at any time and without prior notice, without incurring obligations

1.3 IDENTIFICATION

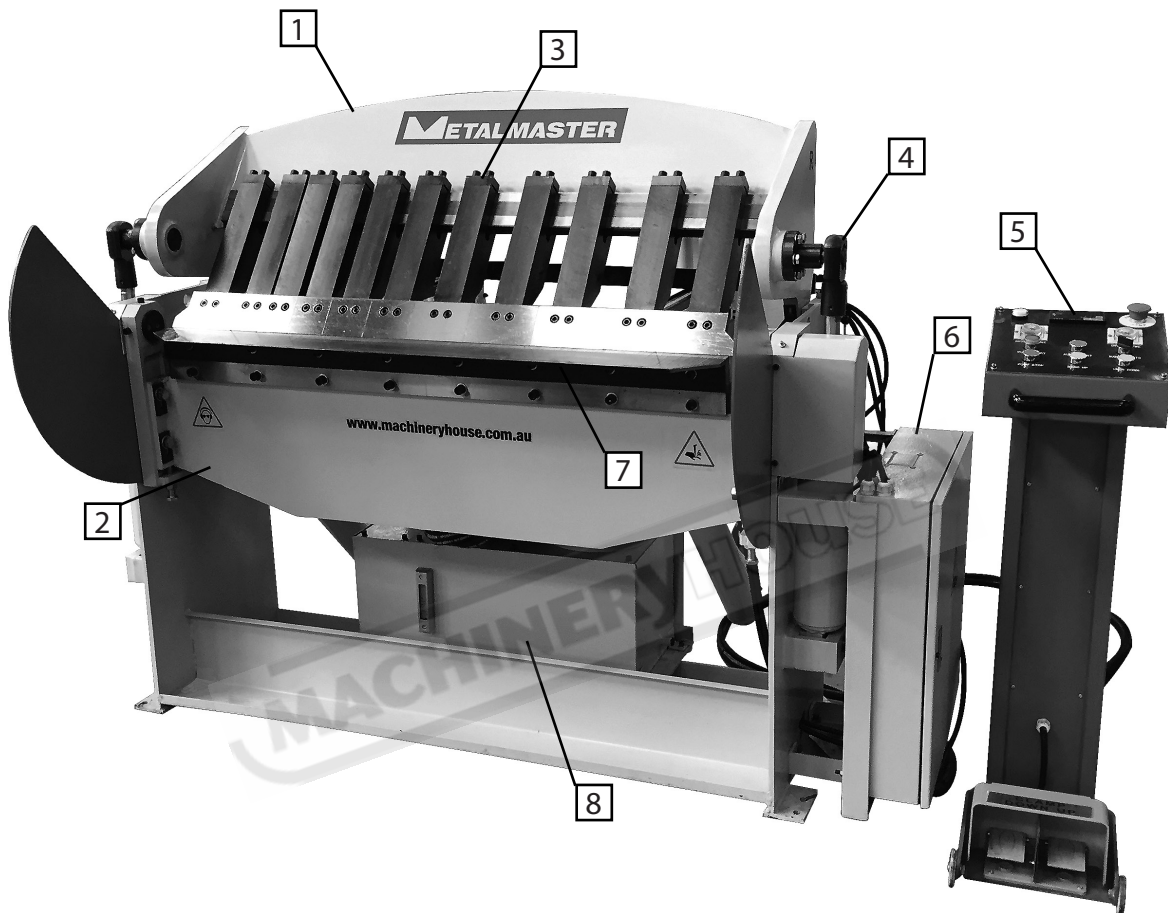

1	Clamping Beam	5	Mobile Foot Control
2	Folding Apron	6	Electrical Cabinet
3	Box Fingers	7	Angle Table
4	Clamping Ram	8	Hydraulic Oil Tank

2.1 GENERAL METALWORKING MACHINE SAFE PRACTICES

DO NOT use this machine unless you have read this manual or have been instructed in the use of this machine in its safe use and operation



WARNING

This manual provides safety instructions on the proper setup, operation, maintenance, and service of this machine. Save this manual, refer to it often, and use it to instruct other operators. Failure to read, understand and follow the instructions in this manual may result in fire or serious personal injury—including amputation, electrocution, or death.

The owner of this machine is solely responsible for its safe use. This responsibility includes, but is not limited to proper installation in a safe environment, personnel training and authorization to use, proper inspection and maintenance, manual availability and comprehension, of the application of the safety devices, integrity, and the use of personal protective equipment.

The manufacturer will not be held liable for injury or property damage from negligence, improper training, machine modifications or misuse.



- ✓ Always wear safety glasses or goggles.
- ✓ Wear appropriate safety footwear.
- ✓ Wear respiratory protection where required.
- ✓ Gloves should never be worn while operating the machine, and only worn when handling the work-piece.
- ✓ Wear hearing protection in areas > 85 dBA. If you have trouble hearing someone speak from one metre (three feet) away, the noise level from the machine may be hazardous.
- ✓ DISCONNECT THE MACHINE FROM POWER when making adjustments or servicing.
- ✓ Check and adjust all safety devices before each job.
- ✓ Ensure that guards are in position and in good working condition before operating.
- ✓ Ensure that all stationary equipment is anchored securely to the floor.
- ✓ Ensure all machines have a start/stop button within easy reach of the operator.
- ✓ Each machine should have only one operator at a time. However, everyone should know how to stop the machine in an emergency.



OPERATION MANUAL

2.1 GENERAL METALWORKING MACHINE SAFE PRACTICES Cont.

- ✓ Ensure that keys and adjusting wrenches have been removed from the machine before turning on the power. Appropriate storage for tooling should be provided.
- ✓ Ensure that all cutting tools and blades are clean and sharp. They should be able to cut freely without being forced.
- ✓ Stop the machine before measuring, cleaning or making any adjustments.
- ✓ Wait until the machine has stopped running to clear cuttings with a vacuum, brush or rake.
- ✓ Keep hands away from the cutting head and all moving parts.
- ✓ Avoid awkward operations and hand positions. A sudden slip could cause the hand to move into the cutting tool or blade.
- ✓ Return all portable tooling to their proper storage place after use.
- ✓ Clean all tools after use.
- ✓ Keep work area clean. Floors should be level and have a non-slip surface.
- ✓ Use good lighting so that the work piece, cutting blades, and machine controls can be seen clearly. Position or shade lighting sources so that they do not cause any glare or reflections.
- ✓ Ensure there is enough room around the machine to do the job safely.
- ✓ Obtain first aid immediately for all injuries.
- ✓ Understand that the health and fire hazards can vary from material to material. Make sure all appropriate precautions are taken.
- ✓ Clean machines and the surrounding area when the operation is finished.
- ✓ Use proper lock out procedures when servicing or cleaning the machines or power tools.
- ✓ Do not distract an operator. Horseplay can lead to injuries and should be strictly prohibited.
- ✓ Do not wear loose clothing, gloves, necktie's, rings, bracelets or other jewellery that can be come entangled in moving parts. Confine long hair.
- ✓ Do not handle cuttings by hand because they are very sharp. Do not free a stalled cutter without turning the power off first. Do not clean hands with cutting fluids.
- ✓ Do not use rags near moving parts of machines.
- ✓ Do not use compressed air to blow debris from machines or to clean dirt from clothes.

DO NOT

- × Do not distract an operator. Horseplay can lead to injuries and should be strictly prohibited.
- × Do not wear loose clothing, gloves, necktie's, rings, bracelets or other jewellery that can be come entangled in moving parts. Confine long hair.
- × Do not handle cuttings by hand because they are very sharp. Do not free a stalled cutter without turning the power off first. Do not clean hands with cutting fluids.
- × Do not use rags or wear gloves near moving parts of machines.
- × Do not use compressed air to blow debris from machines or to clean dirt from clothes.
- × Do not force the machine. It will do the job safer and better at the rate for which it was designed.



OPERATION MANUAL

2.1 GENERAL METALWORKING MACHINE SAFE PRACTICES Cont.

HAZARDS ASSOCIATED WITH MACHINES include, but are not limited to:

- Being struck by ejected parts of the machinery
- Being struck by material ejected from the machinery
- Contact or entanglement with the machinery
- Contact or entanglement with any material in motion

Health Hazards (other than physical injury caused by moving parts)

- Chemicals hazards that can irritate, burn, or pass through the skin
- Airborne items that can be inhaled, such as oil mist, metal fumes, solvents, and dust
- Heat, noise, and vibration
- Ionizing or non-ionizing radiation (X-ray, lasers, etc.)
- Biological contamination and waste
- Soft tissue injuries (for example, to the hands, arms, shoulders, back, or neck) resulting from repetitive motion, awkward posture, extended lifting, and pressure grip)

Other Hazards

- Slips and falls from and around machinery during maintenance
- Unstable equipment that is not secured against falling over
- Safe access to/from machines (access, egress)
- Fire or explosion
- Pressure injection injuries from the release of fluids and gases under high pressure
- Electrical Hazards, such as electrocution from faulty or ungrounded electrical components
- Environment in which the machine is used (in a machine shop, or in a work site)



Machines are safeguarded to protect the operator from injury or death with the placement of guards. Machines must not be operated with the guards removed or damaged.



OPERATION MANUAL

2.2 SAFETY SPECIFIC TO PANBRAKES

DO NOT use this machine unless you have been instructed in its safe use and operation or have read and understood this manual.

PERSONAL PROTECTIVE EQUIPMENT



Safety glasses must be worn at all times in work areas



Long and loose hair must be contained.



Gloves must not be worn when using this machine.



Sturdy footwear must be worn at all times in work areas



Close fitting/protective clothing must be worn



Rings and jewelry must not be worn.

PRE-OPERATIONAL SAFETY CHECKS

- ✓ Locate and ensure you are familiar with all machine operations and controls.
- ✓ Ensure all guards are fitted, secure and functional. Do not operate if guards are missing or faulty.
- ✓ Ensure working parts are well lubricated and the jaws and fingers free of rust and dirt.
- ✓ Check workspaces and walkways to ensure no slip/trip hazards are present
- ✓ Be aware of other people in the area. Ensure the area is clear before using equipment.

OPERATIONAL SAFETY CHECKS

- ✓ Remove the pan brake fingers that are in the way. Use only the pan brake fingers required to make the bend.
- ✓ Ensure the pan brake fingers that are not removed for an operation are securely seated and firmly tightened before the machine is used.
- ✓ Ensure your fingers and limbs are clear before operating the pan brake.
- ✓ Lower finger clamps to work. Do not drop.
- ✓ Check workpiece is secure.
- ✓ Keep clear of moving counterweight (where fitted).

ENDING OPERATIONS AND CLEANING UP

- ✓ Lower finger clamps to a safe position.
- ✓ Return all accessories to storage racks.
- ✓ Leave the work area in a safe, clean and tidy state.

POTENTIAL HAZARDS AND INJURIES

- ✓ Sharp edges and burrs.
- ✓ Squash/crush and pinch points.
- ✓ Impact from counterweight.

DON'T

- ✓ Do not use faulty equipment. Immediately report suspect machinery.
- ✓ Do not use a pan brake for bending metal that is beyond its capacity for thickness, shape or type.
- ✓ Do not attempt to bend rod, wire, strap or spring steel sheets.

2.3 LIFTING INSTRUCTIONS

On the day that the machine arrives, make sure that a crane with sufficient capacity is available to unload the machine from the vehicle. Ensure access to the chosen site is clear and that doors and ceilings are sufficiently high and wide enough to receive the machine.

To handle the machine, the slings should be positioned so the machine is level when lifted. When using slings please take note of the sling angle and the loads that apply

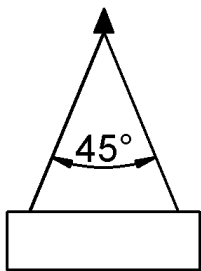

Fig 2.1.

When the slings are at a 45° angle then each sling is carrying the equivalent of 50% of load weight. (Fig.2.1).

When the slings are at a 90° angle then each sling will have a weight equal to 75% of the load on each sling. (Fig 2.2)

Note! The manufacturer recommends not to exceed 90° angle

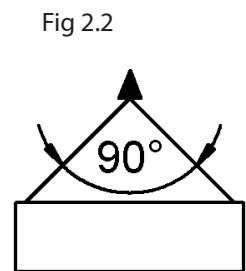

Fig 2.2

When lifting the machine only certified lifting slings should be used. Ensure that when lifting, the machine does not tip over. Check that the lifting slings do not interfere with the hydraulic pipes or electrical conduits. Failure to follow these instructions could cause damage to the machine

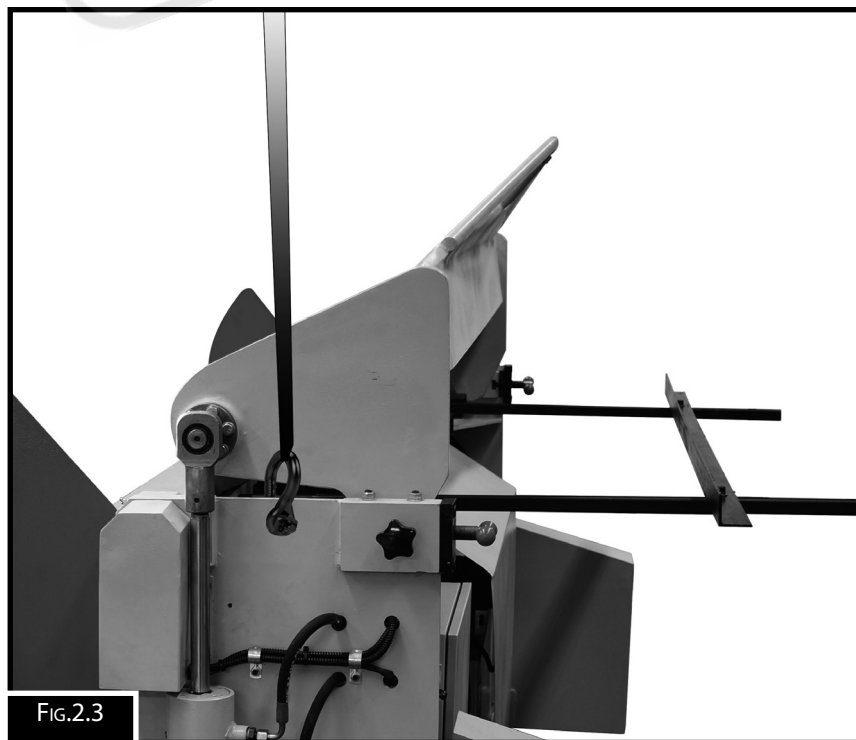

FIG.2.3



OPERATION MANUAL

3. SETUP

3.1 SITE PREPARATION

When selecting the site for the machine, consider the largest size of workpiece that will be processed through the machine and provide enough space around the machine for operating the machine safely. Consideration should be given to the installation of auxiliary equipment. Leave enough space around the machine to open or remove doors/covers as required for the maintenance and service as described in this manual.

It is recommended that the machine is anchored to the floor to prevent tipping or shifting. It also reduces vibration that may occur during operation. The machine should be mounted on a reinforced concrete floor with a minimum of 150mm thickness. The floor must be able to support the weight of the machine and any workpiece that is to be worked.

3.2 CLEAN - UP

The unpainted surfaces of the machine have been coated with a waxy oil to protect them from corrosion during shipment. Remove the protective coating with a solvent cleaner or a citrus based degreaser.

Optimum performance from your machine will be achieved when you clean all moving parts or sliding contact surfaces that are coated with rust prevented products.

Metalmaster advise to avoid chlorine based solvents, such as acetone or brake parts cleaner, as they will damage painted surfaces and strip metal should they come in contact. Always follow the manufacturer's instructions when using any type of cleaning product.

OPTIONS FOR MOUNTING

The machine is best mounted on a concrete slab. Masonry anchors with bolts are the best way to anchor machinery, because the anchors sit flush with the floor surface, making it easy to unbolt and move the machine later, if needed. (Fig. 3.1)

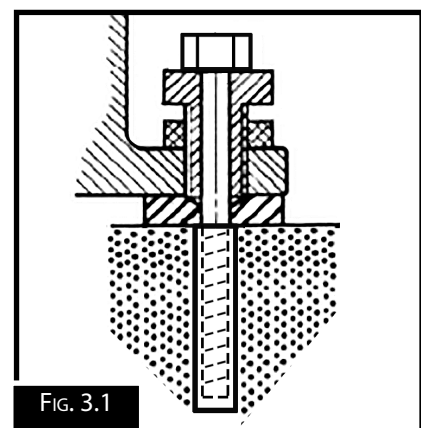

FIG. 3.1

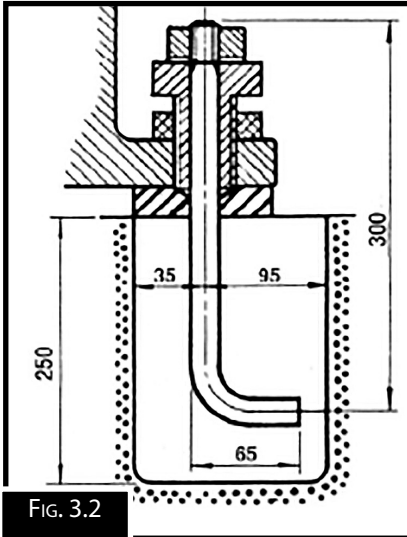

Fig. 3.2

In some case a suitable foundation may not be available and a new one may need to be prepared.

The foundation should be concrete approximately 200mm thick with pockets left clear for the hold down bolts. The hold down bolts can be "L" shape as per the example in Fig. 3.2

3.3 MACHINE LEVELING

To set your machine up so that it operates to optimum performance, apply the following procedure

After your machine has been anchored to a concrete slab floor, it then needs to be leveled. Loosen the hold down bolts and place a level on the surface of the working table. A metal plate needs to be placed under corner of the base of the machine and the jacking screw adjusted until level. Once level then tighten the hold down bolts. (Fig. 3.3).

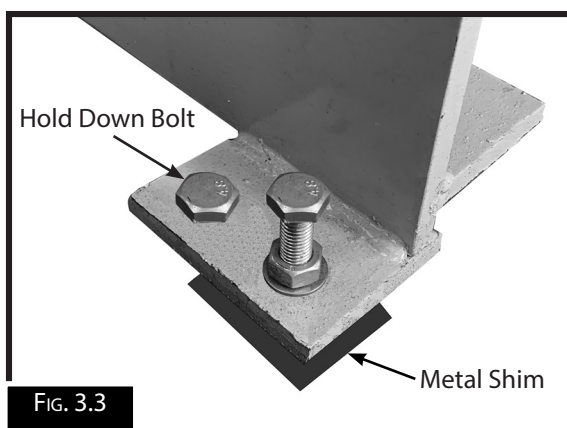

Fig. 3.3



The machine must not rest on supports other than those defined in Fig. 3.3



OPERATION MANUAL

3.4 ELECTRICAL INSTALLATION

Place the machine near an existing power source. Make sure all power cords are protected from traffic, material handling, moisture, chemicals, or other hazards. Make sure there is access to a means of disconnecting the power source. The electrical circuit must meet the requirements for 240V. To minimize the risk of electrocution, fire, or equipment damage, these machines should be connected directly to a power point.

NOTE : The use of an extension cord is not recommended as it may decrease the life of electrical components on your machine.

ELECTRICAL REQUIREMENTS

Nominal Voltage.....240V
Cycle.....50 Hz
Phase.....Single Phase
Power Supply Circuit.....15 Amps
Full Load Current.....12.8 Amps

(Full load current rating is also on the specification plate on the motor.)

3.5 FULL-LOAD CURRENT RATING

The full-load current rating is the amperage a machine draws at when running at 100% of the output power. Where machines have more than one motor, the full load current is the amperage drawn by the largest motor or a total of all the motors and electrical devices that might operate at one time during normal operations.

Full-Load Current Rating for these machine at 240V is 12.8 Amps

It should be noted that the full-load current is not the maximum amount of amps that the machine will draw. If the machine is overloaded, it will draw additional amps beyond the full-load rating and if the machine is overloaded for a long period of time, damage, overheating, or fire may be caused to the motor and circuitry.

This is especially true if connected to an undersized circuit or a long extension lead. To reduce the risk of these hazards, avoid overloading the machine during operation and make sure it is connected to a power supply circuit that meets the requirements.



3.6 ATTACHING THE ACCESSORIES

Before the machine is operated the accessories need to be assembled and mounted onto the machine. The following accessories need to be fitted

NOTE: the machine must not be used unless the safety guards have been installed correctly.

- Bolt on the two apron safety guards (Fig 3.4)

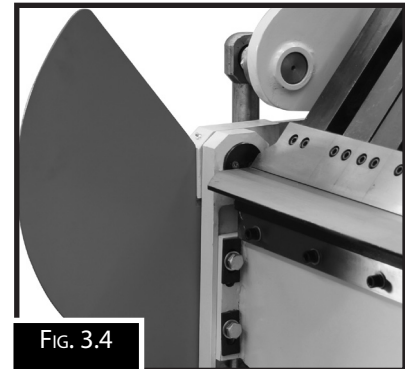

FIG. 3.4

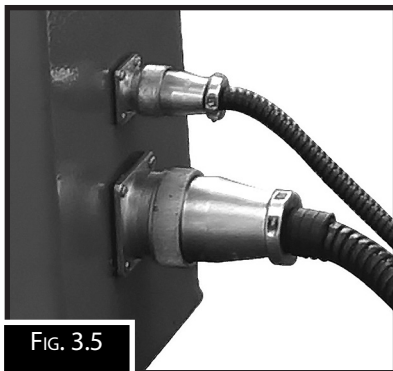

FIG. 3.5

- Connect the roving foot pedal to the machine by inserting the two control cables and locked in by screwing the securing cap on to the plug. (Fig. 3.5)

- Install the manual back gauge making sure that the packing blocks are in place to raise the back gauge to the correct height (Fig. 3.6)



FIG. 3.6

3.7 FILL THE HYDRAULIC OIL TANK.

To fill the tank with oil

1. Remove the oil tank cover.
2. Make sure the inside of the tank is clean and clear of any dirt
3. Using a pump, fill the tank with oil until the level reaches the centre mark of the oil indicator. Observation of the oil level indicator should be done regularly to ensure the oil is kept at the same level.

When filling the tank with oil, make sure that the top of the tank is clean and free from dust and dirt.

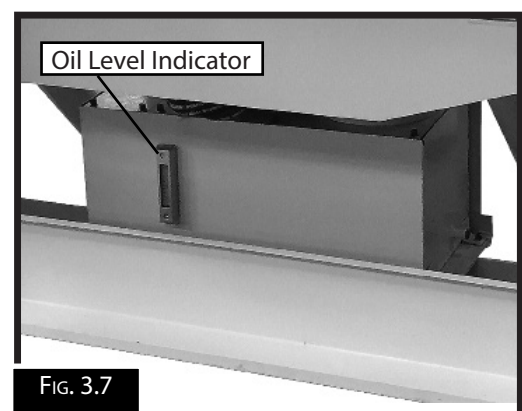

FIG. 3.7

4. OPERATION

4.1 SETTING THE CLAMP GAP

Before operating the machine the clamp gap needs to be set to match the material thickness

The Clamp gap must be set to a minimum of 1.5 x material thickness. (Fig. 4.1)

Example: If the material that is to be bent is 2mm then the clamp gap must be set to a minimum of 3mm.

Each panbrake may have different mechanisms for adjusting the clamp gap but the formula of 1.5 x Material Thickness must be maintained to prevent overload and possible damage.

These machines are fitted with an easy to use clamp beam adjustment. There are two adjustment screws (Fig.4.2) on the machine situated on each side of the machine.

To adjust

1. Loosen the lock screws on both sides
2. Turn the two adjusting screws until the gap (Fig.4.2) is correct.
3. Tighten the two lock screws and recheck the gap

If needed, a combination of top clamp adjustment and apron adjustment can be applied.

NOTE: The locking bolts on the apron must be released before adjusting, then tightened when the correct height is reached.

RETURN LENGTH - LIMITATION

Caution - There is a minimum "Return Length" of 15 x Thickness of Material when bending thicker material over 1mm. Damage could occur to the machine if the return is too short.

Example: If bending 2mm the minimum return length must be 30mm (Fig. 4.4)

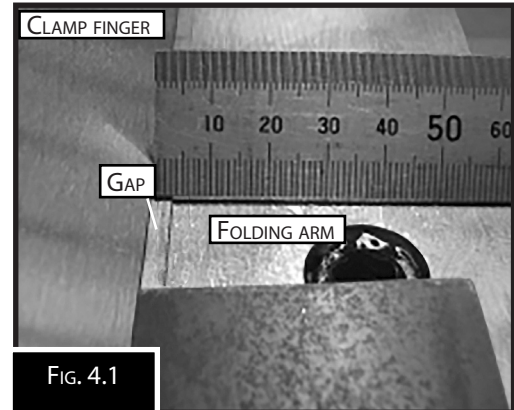

FIG. 4.1

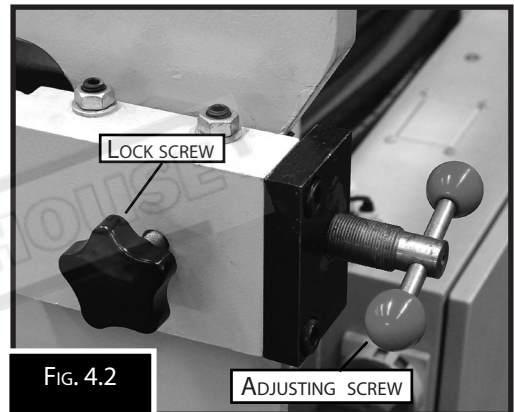

FIG. 4.2



FIG. 4.3

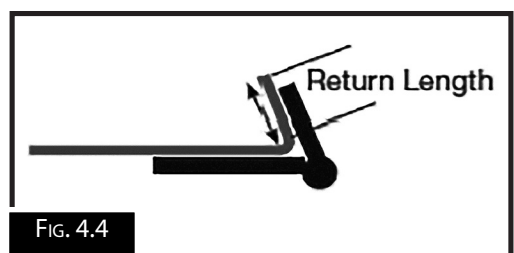
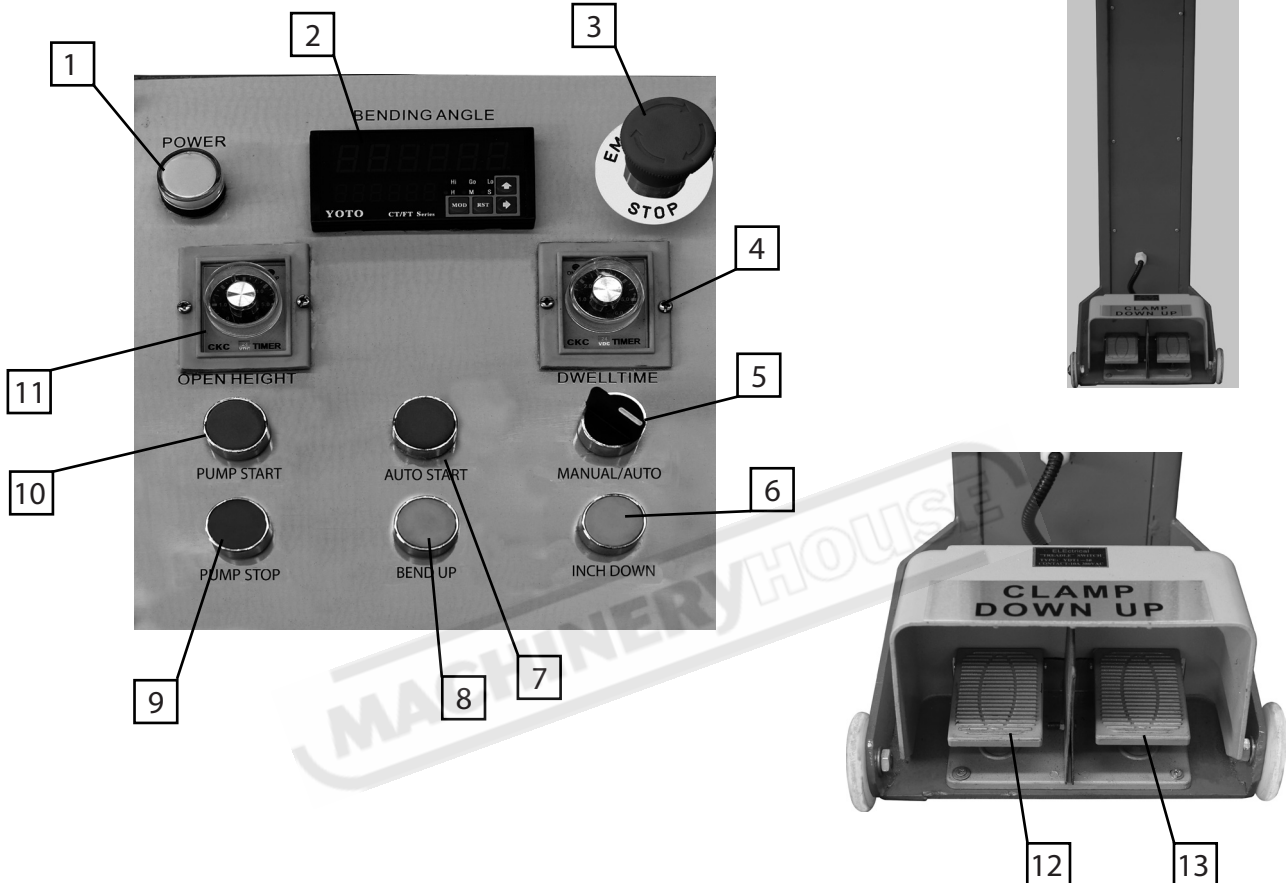

FIG. 4.4

4.2 OPERATING CONTROLS

The controls for the machine are situated on the roving foot pedal



1. **Power Button:** Switches the electrical circuit on
2. **Yoto Controller:** Programs the operation (See 4.2 Controller Operation).
3. **Emergency Stop:** When pressed switches off the electric circuit of the machine. The red knob must be twisted to be released before the machine can be restarted.
4. **Dwell Timing:** Sets the amount of delay at the Apron is stationary at the end of the bend before returning.
5. **Manual/Auto Switch:** Selects between either manual of automatic operation.
6. **Inch Down:** When pressed lowers the apron when in "Manual" mode.
7. **Auto Start:** Once "Auto" (#5) is selected, then when pressed completes one cycle.
8. **Bend Up:** When in "Manual" mode raises the apron when pressed
9. **Pump Stop:** Stops the hydraulic pump
10. **Pump Start:** Starts the hydraulic pump
11. **Open Height:** Sets the opening of the clamp beam when "Auto" is selected.
12. **Left Foot Pedal:** When pressed lowers the clamping beam approx 10mm.
13. **Right Foot Pedal:** When pressed raises the clamp beam.



OPERATION MANUAL

4.3 CONTROLLER OPERATION

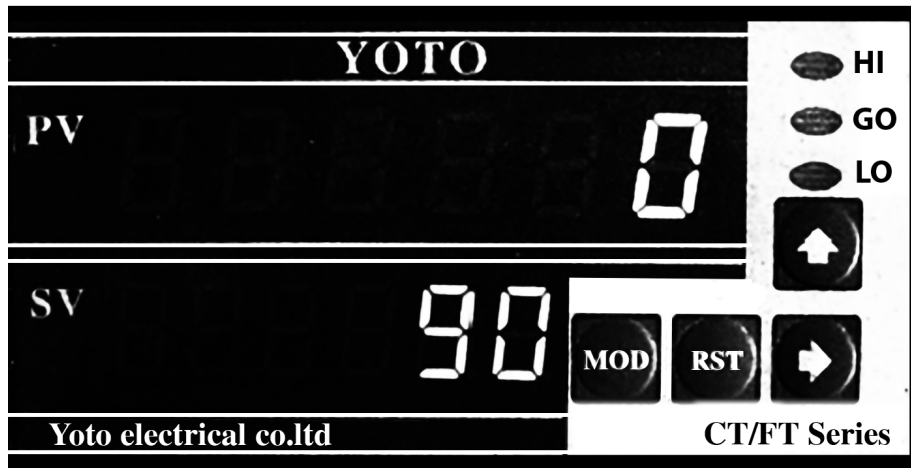

SETTING BENDING ANGLE VALUE

(For Auto mode bending,)

NOTE: The set value (SV) is not the angle in degrees it will bend, it is just a reference number, that the bending beam will go to repeatedly. The angle will change due to spring-back of the work piece depending on material type, thickness and length.

("SV"= Set Value or what the PV value will stop at when it reaches it.)

Ensure the bending beam is all the way down.

Press the red **RST** "RST" button on the display, and this will reset the "PV" (P Value) to Zero. To get a set bending angle, the set Value (SV) will have to be worked out by "trial and error" bending and then recorded elsewhere for future use.

Value/Angle relationships will also change depending on type and thickness of material being bent.

Press the blue right hand pointing arrow. The S Value column of the display will start flashing. Each time you press this arrow, it will move the flashing digit across to the next one.

When you reach the digit you want to change, then stop. Then press the up arrow until you reach the required number going from zero up to 9 and back to zero etc.

Repeat until the correct value is set.

Then press the **MOD** "MOD" button.

The display is now set to bend to this Value. The machine Auto will count up by the P Value and stop when it equals the S Value you have set on the display.



OPERATION MANUAL

4.3 CONTROLLER OPERATION Cont.

MANUAL BENDING

NOTE: You can use the PV display to show you the position you have bent to in manual. This can be used to repeat a bend on following manual bent pieces the same size"

- Ensure the emergency stop button is released. (STOP)
- Start the hydraulic pump. (PUMP START)
- Set the BENDING ANGLE Display "SV" to 200.00 SEE "SETTING DISPLAY"
- Switch the MANUAL/AUTO to Manual
- Raise the top work clamp
- Ensure the top blade clearance is set for correct thickness of material to be bent
- Put the work piece in to the correct mark on job or use the back gauge to set length of bend.
- Clamp the work piece in the machine

WARNING: DO NOT BEND THE WORK PIECE OR RAISE THE BENDING ARM UNTIL THE WORK IS FULLY CLAMPED AND OR TOP CLAMP IS DOWN. FAILURE TO ABIDE BY THIS COULD CAUSE DAMAGE TO THE MACHINE.

NB There is a safety limit switch fitted to the machine to prevent the bending beam from operating unless it is in the down position.

To Bend

- Press BEND UP foot pedal, the bending beam will come up until it is released at required bend angle.
Check angle and re-bend further if needed.
- Press "BENDING DOWN" to lower bending beam.

AUTOMATIC BENDING.

- Ensure emergency stop button is released.
- Start hydraulic pump
- Set Bending angle on BENDING ANGLE Display ("S Value) to the required Value! See "SETTING BENDING ANGLE VALUE (please note: the set value is not the angle in degrees it will bend, it is just a number that the bending beam will go to repeatedly.)
- Switch to manual/Auto switch to Auto
- Raise the top work clamp
- Ensure top blade back clearance is set to thickness of material to be bent
- Put work piece in to correct mark or use back gauge to set length
- Clamp work piece

WARNING.. DO NOT BEND WORK PIECE OR RAISE BENDING ARM UNTIL WORK IS CLAMPED AND OR TOP CLAMP IS DOWN. FAILURE TO ABIDE BY THIS COULD CAUSE DAMAGE TO THE MACHINE.

To Bend in auto

- Press Auto/Start button.

The bending beam will now come up to the set value, return to zero and you can then release manual hand clamp.

To Auto bend again you must turn switch to neutral position and then back to Au



OPERATION MANUAL

4.4 START UP

- Check that the electrical supply has been connected.
- Check that the hydraulic tank has been filled with hydraulic oil.
- Ensure that the emergency stop button is in the released position.
- Ensure the isolating switch is on and power light is illuminated
- Press the hydraulic pump button to start the electric motor

4.5 BENDING

- Set the bend angle according to your requirements.
- Ensure the clamp gap has been set according to the thickness of the plate.
- Once the steel plate is in position for bending then the choice of inching or cycle mode can be selected.
- Do not bend material which has been welded or deformed.

5. MAINTENANCE

5.1 TYPE AND FREQUENCY OF INSPECTIONS

Inspection	Frequency	Responsible
Lubrication of all grease points	Daily	Operator
Lubrication of clamp fingers and machine surfaces	Daily	Operator
Guards for physical damage	Daily	Operator
Machine fixing bolts against loosening	Weekly	Operator
Oil Leakage in cylinders	Weekly	Operator
Oil leakages in hoses, pipes and hydraulic parts	Weekly	Operator
Hydraulic fluid levels	Weekly	Operator
Cylinder connecting bolts against loosening	Weekly	Operator
Safety and limit switches against loosening	Weekly	Operator
Electrical terminal connections	Annually	Electrician



OPERATION MANUAL

5.2 CHANGING THE HYDRAULIC OIL

The efficiency of the Metalmaster machine relies on the hydraulic system being well maintained. All precautions must be taken to keep the hydraulic system clean at all times.

To change the oil

1. Remove the 4 socket head cap screws holding the tank cover and remove the oil tank cover. (Fig.5.1)
2. Using an appropriate pump, drain out the old oil completely making sure nothing is left.
3. Using a clean cloth wipe out the tank to make sure any dirt or foreign objects have been removed.
4. Using a pump, fill the tank with new 46 grade hydraulic oil until the oil reaches the centre mark of the oil indicator. The oil level must be checked regularly to make sure it is always kept at the same level.
5. When changing oil, keep the oil tank clean and free of dirt at all times..
6. Oil must be changed after the first 200 working hours of use, and then after every 1000 working hours.

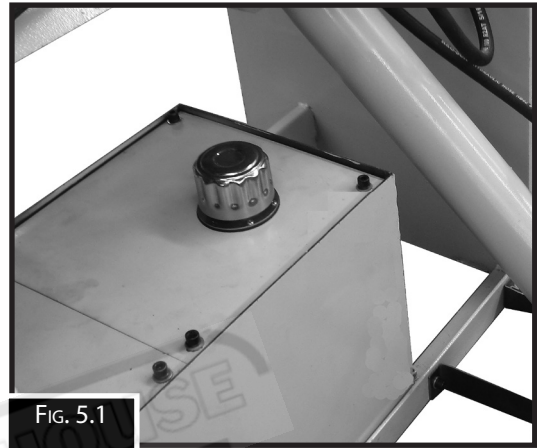

5.2 CHANGING THE HYDRAULIC OIL FILTER

From time to time the hydraulic oil filter may need to be changed to ensure the quality of the system. Filters used by the manufacture may change from model to model but basic procedure is listed below.

To change the oil

1. Remove the 4 socket head cap screws holding the tank cover and remove the oil tank cover. (Fig.5.1)
2. Using an appropriate pump, drain out the old oil completely making sure nothing is left.
3. Using a clean cloth wipe out the tank to make sure any dirt or foreign objects have been removed.
4. Unscrew the filter off the intake tube (Fig.5.2) at the bottom of the tank and replace with a new filter.
5. Using a pump, fill the tank with new 46 grade hydraulic oil until the oil reaches the centre mark of the oil indicator. The oil level must be checked regularly to make sure it is always kept at the same level.
5. When changing the oil filter, keep the oil tank clean and free of dirt at all times.
6. The oil filter should be changed after 1000 hours of operation

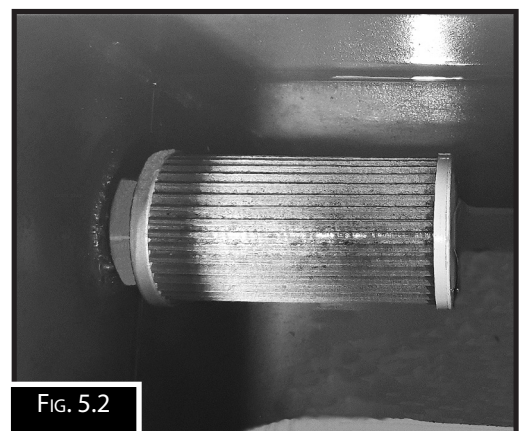



OPERATION MANUAL

5.3 TROUBLE SHOOTING

If the machine develops a problem, review the trouble shooting section below to find a fix for the problem. If the problem cannot be solved then contact your dealer for help or to book a service engineer.

PROBLEM	POSSIBLE CAUSES	CORRECTION
Material bend is uneven	<ol style="list-style-type: none"> 1. Clamp setting wrong for the material thickness. 2. Finger edges are uneven 	Re-adjust cam settings Adjust pan clearance Adjust fingers
No Clamping	Pressure relief valve is blocked Failure in the pressure relief valve Directional valve is blocked Failure of directional valve Suction filter is blocked Pump failure Leakage in the pipes or cylinder	* Clean valve *Change valve * Clean valve * Change valve * Clean filter * Check pump and change if necessary * Find the leaks and repair *Press reset button
Apron does not operate	Low pressure in lifting cylinders Leakage in lifting cylinders	* Check system pressure *Replace piston seal
Oil leaking from cylinder	Gland seal is damaged	*Change seal
Oil leaking from fittings	Loose fittings	*Tighten fittings



OPERATION MANUAL

SPARE PARTS SECTION

The following section covers the spare parts diagrams and lists that were current at the time this manual was originally printed. Due to continuous improvements of the machine, changes may be made at any time without notification.

HOW TO ORDER SPARE PARTS

1. Have your machines **model number, serial number & date of manufacture** on hand, these can be found on the specification plate mounted on the machine
2. A scanned copy of your parts list/diagram with required spare part/s identified
3. Go to www.machineryhouse.com.au/contactus and fill out the enquiry form attaching a copy of scanned parts list.





OPERATION MANUAL

ELECTRICAL DIAGRAM

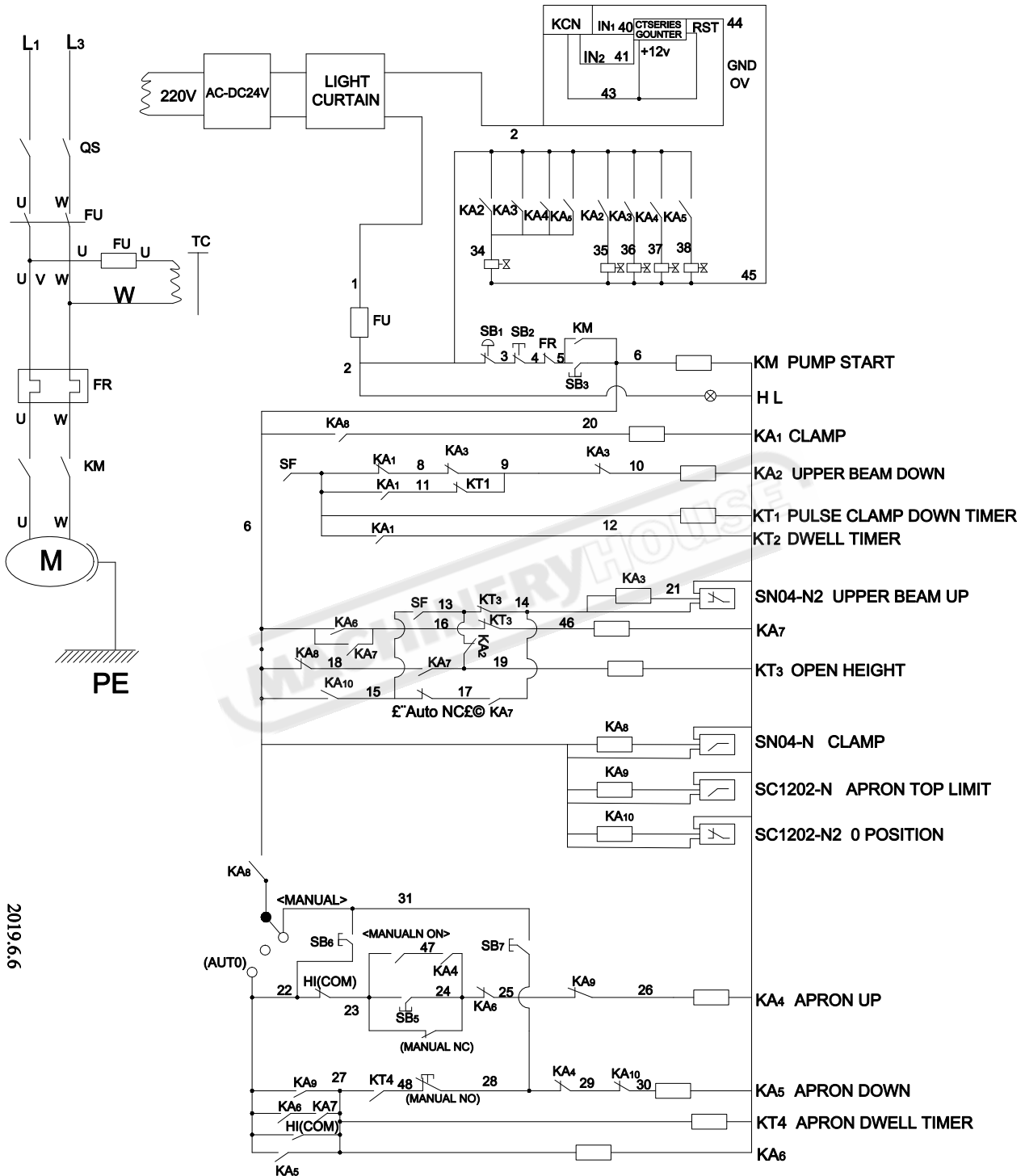



OPERATION MANUAL

HYDRAULIC DIAGRAM

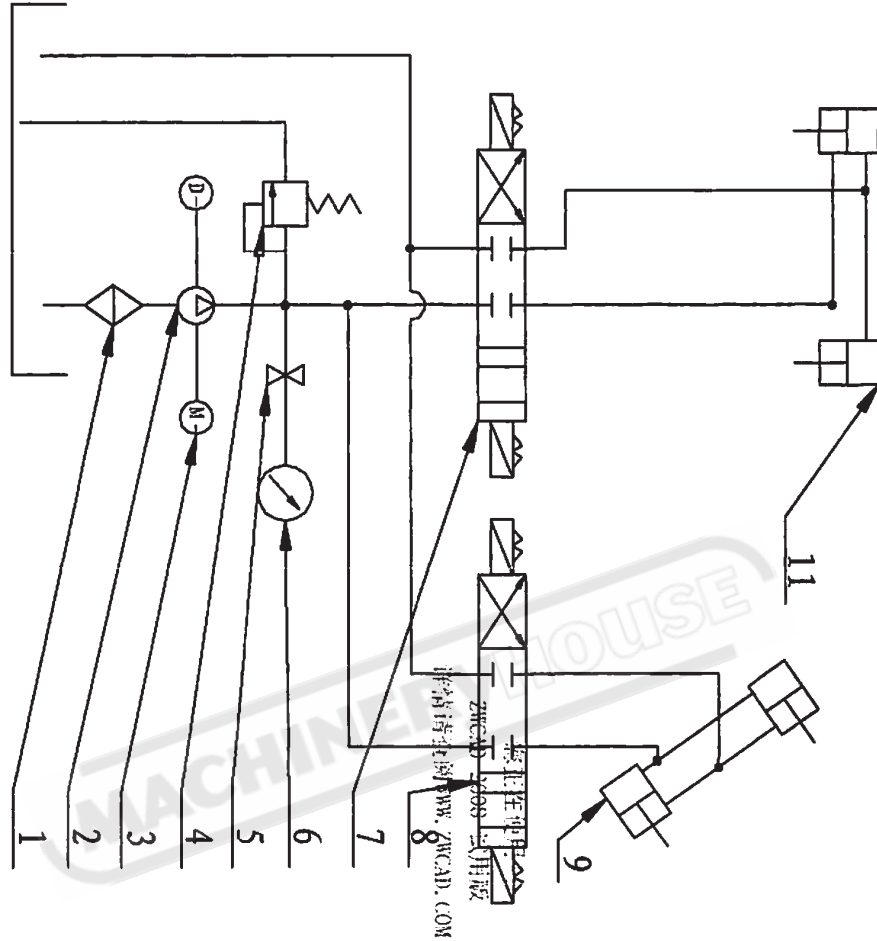

- 1. Filter
- 2. Motor 4KW/Y132S-4
- 3. Pressure Gauge YN-60
- 4. Pressure Gauge Adjuster K-H6
- 5. Superposition of electromagnetic valve
- 6. Superposition of one-way valve
- 7. Leaf Oil Pump
- 8. Pressure Regulator Control Valve
- 9. Pressure Gauge YN-60
- 10. Folding Hydraulic Cylinder
- 11. On Beam Hydraulic Cylinder

Maximum Pressure 8 Bar



WARNING

General Machinery Safety Instructions

Machinery House
requires you to read this entire Manual before using this machine.

- 1. Read the entire Manual before starting machinery.** Machinery may cause serious injury if not correctly used.
- 2. Always use correct hearing protection when operating machinery.** Machinery noise may cause permanent hearing damage.
- 3. Machinery must never be used when tired, or under the influence of drugs or alcohol.** When running machinery you must be alert at all times.
- 4. Wear correct Clothing.** At all times remove all loose clothing, necklaces, rings, jewelry, etc. Long hair must be contained in a hair net. Non-slip protective footwear must be worn.
- 5. Always wear correct respirators around fumes or dust when operating machinery.** Machinery fumes & dust can cause serious respiratory illness. Dust extractors must be used where applicable.
- 6. Always wear correct safety glasses.** When machining you must use the correct eye protection to prevent injuring your eyes.
- 7. Keep work clean and make sure you have good lighting.** Cluttered and dark shadows may cause accidents.
- 8. Personnel must be properly trained or well supervised when operating machinery.** Make sure you have clear and safe understanding of the machine you are operating.
- 9. Keep children and visitors away.** Make sure children and visitors are at a safe distance for you work area.
- 10. Keep your workshop childproof.** Use padlocks, Turn off master power switches and remove start switch keys.
- 11. Never leave machine unattended.** Turn power off and wait till machine has come to a complete stop before leaving the machine unattended.
- 12. Make a safe working environment.** Do not use machine in a damp, wet area, or where flammable or noxious fumes may exist.
- 13. Disconnect main power before service machine.** Make sure power switch is in the off position before re-connecting.
- 14. Use correct amperage extension cords.** Undersized extension cords overheat and lose power. Replace extension cords if they become damaged.
- 15. Keep machine well maintained.** Keep blades sharp and clean for best and safest performance. Follow instructions when lubricating and changing accessories.
- 16. Keep machine well guarded.** Make sure guards on machine are in place and are all working correctly.
- 17. Do not overreach.** Keep proper footing and balance at all times.
- 18. Secure workpiece.** Use clamps or a vice to hold the workpiece where practical. Keeping the workpiece secure will free up your hand to operate the machine and will protect hand from injury.
- 19. Check machine over before operating.** Check machine for damaged parts, loose bolts, Keys and wrenches left on machine and any other conditions that may effect the machines operation. Repair and replace damaged parts.
- 20. Use recommended accessories.** Refer to instruction manual or ask correct service officer when using accessories. The use of improper accessories may cause the risk of injury.
- 21. Do not force machinery.** Work at the speed and capacity at which the machine or accessory was designed.
- 22. Use correct lifting practice.** Always use the correct lifting methods when using machinery. Incorrect lifting methods can cause serious injury.
- 23. Lock mobile bases.** Make sure any mobile bases are locked before using machine.
- 24. Allergic reactions.** Certain metal shavings and cutting fluids may cause an allergic reaction in people and animals, especially when cutting as the fumes can be inhaled. Make sure you know what type of metal and cutting fluid you will be exposed to and how to avoid contamination.
- 25. Call for help.** If at any time you experience difficulties, stop the machine and call you nearest branch service department for help.



Hydraulic Panbrake Safety Instructions

Machinery House
requires you to read this entire Manual before using this machine.

- 1. Maintenance.** Make sure the Panbrake is turned off and disconnect from the main power supply and make sure all moving parts have come to a complete stop before any inspection, adjustment or maintenance is carried out.
- 2. Panbrake Condition.** Panbrake must be maintained for a proper working condition. Never operate a Panbrake that has low oil levels, damaged or worn parts. Scheduled routine maintenance should be performed on a scheduled basis.
- 3. Tooling Condition.** Never operate a Panbrake with damaged or badly worn tooling. Replace if required.
- 4. Pump Direction.** Pump rotation must be in arrow direction otherwise the pump will be damaged.
- 5. Hand Hazard.** Do not insert or extend your hands in between bending tools, under any circumstances, while the machine is in operation mode. Serious injury can occur.
- 6. Gloves & Glasses.** Always wear leather gloves and approved safety glasses when using this machine.
- 7. Authorized and trained personnel.** The machine must be operated by authorized and trained personnel. The machine is designed to be operated by a single user. Using the machine with more than one operator is forbidden, except for certain maintenance situations.
- 8. Power outage.** In the event of a power failure during use of the machine, turn off all switches to avoid possible sudden start up once power is restored.
- 9. Work area hazards.** Keep the area around the Panbrake clean from oil, tools, objects & chips. Pay attention to other persons in the area and know what is going on around the area to ensure unintended accidents. Do not access the rear of machine, while the machine is working
- 10. Guards.** Operate machine only with all protective devices and guarding.
- 11. Overloading Panbrake.** Do not exceed the rated capacity of the machine. Refer to the manual for correct capacities.
- 12. Warning Labels.** Take note of any warning labels on the machine and do not remove them.
- 13. Operation.** During the bending process, the workpiece may leap up. Therefore, the material must be handled carefully.
- 14. Emergency stop.** Use the emergency stop button in case of any emergency.
- 15. Level machine.** Level the machine on a flat concrete surface by using a spirit level.
- 16. Floor load for Installation.** The permissible floor load, where the machine is to be installed, must be accounted for.
- 17. Hearing protection and hazards.** Always wear hearing protection as noise generated from machine and workpiece can cause permanent hearing loss over time.
- 18. Heating Material.** Heating metal with a torch while the metal is in the bending brake will weaken the fingers.
- 19. Pinching.** Prevent pinching by lowering the panbrake fingers when not in use.
- 20. Call for help.** If at any time you experience difficulties, stop the machine and call your nearest branch service department for help.

PLANT SAFETY PROGRAM

NEW MACHINERY HAZARD IDENTIFICATION, ASSESSMENT & CONTROL

Hydraulic Panbrake

Developed in Co-operation Between A.W.I.S.A and Australia Chamber of Manufactures
This program is based upon the Safe Work Australia, Code of Practice - Managing Risks of Plant in the Workplace (WHSA 2011 No10)



Item No.	Hazard Identification	Hazard Assessment	Risk Control Strategies <small>(Recommended for Purchase / Buyer / User)</small>
B	CRUSHING	MEDIUM	Secure & support work material. Keep hands clear of folder blades when clamping.
C	CUTTING, STABBING, PUNCTURING	MEDIUM	Wear gloves to prevent cuts from sharp material offcuts. Care must be taken when handling folder blades.
D	SHEARING	MEDIUM	Body parts should be kept clear of moving parts. Isolate power to machine prior to any checks or maintenance. Do not adjust or clean until machine has fully stopped.
F	STRIKING	MEDIUM	Ensure guards are secured properly. Wear safety glasses. Ensure blade fingers are secured to clamp beam. Keep clear of bending material.
H	ELECTRICAL	MEDIUM	Ensure clamp beam is correctly adjusted. Machine should be installed & checked by a Licensed Electrician. All electrical enclosures should only be opened with a tool that is not to be kept with the machine.
O	OTHER HAZARDS, NOISE.	LOW	Wear hearing protection as required.
Plant Safety Program to be read in conjunction with manufactures instructions			



www.machineryhouse.com.au



www.machineryhouse.co.nz

Authorised and signed by:
Safety officer: 
Manager: 

Revised Date: 12th March 2012